

股票代號：4583

台灣精銳科技股份有限公司 APEX DYNAMICS, INC.

主講人：郭崇哲 總經理

2024 年 3 月 19 日



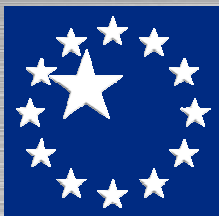

免責聲明

本報告內容及同時發佈的相關訊息內，含現有從公司內部與外部來源所取得的預測性資訊。

The prospective statements released or mentioned in this presentation are based on our company's data and information available as well as the current situation.

本公司未來實際所發生的營運結果、財務狀況及業務展望，可能與這些預測性資訊所明示或暗示的預估有所差異，其原因可能來自於各種本公司無法掌控的風險和不確定性因素影響。

Such statements may be affected by known and unknown risks and inherent uncertainties, the existence or emergence of facts or factors that differ from the assumptions, suppositions, or judgments of the Company, or other factors. Consequently, there may be significant discrepancies between actual results pertaining to the Company's future earnings, management results, financial conditions, and other matters as explicitly or implicitly referred to in the statements and the content of such statements.

本報告中的內容及其他所有資料，僅為資訊流通之目的而公佈，並非投資建議，本公司不保證報告內容的正確性、完整性，未來如有任何變更或調整時，本公司並不負責隨時提醒或更新。

The presentation is run exclusively for the purpose of providing information and not for the purpose of soliciting investments or recommending the buying or selling of specific shares or products. Our company does not guarantee the accuracy or completeness of the information nor undertake any obligation to update or correct any forward-looking statements, whether as a result of new information or future events.

本公司不對使用本報告內容所產生的損害負任何責任。

Our company will not be liable for any damages arising out of use of the information.

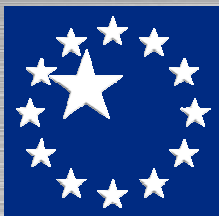

- 公司簡介
- 競爭利基
- 營運實績
- 市場展望
- **Q&A**

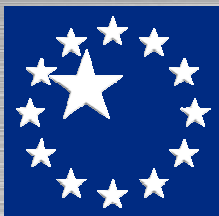

➤ 公司簡介

➤ 競爭利基

➤ 營運實績

➤ 市場展望

➤ Q&A

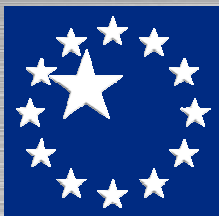

公司簡介 – 基本資訊

- ➔ 成立時間：1999年10月26日
- ➔ 公司地址：台中市西屯區科園三路10號 (總公司、一廠)
台中市西屯區科園二路10號 (二廠)
台中市中科后里園區后科南路18號 (三廠)
台中市西屯區市政路77號 (日月千禧酒店)
- ➔ 營運項目：行星式減速機、客房及餐飲服務、其它
- ➔ 資本額： 新臺幣 801,714千元
- ➔ 員工人數： 990人 (2023年12月底止)

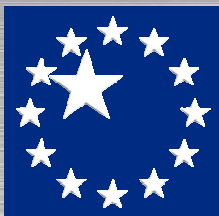

公司簡介 - 營業處所

中科園區 - 台灣精銳總公司 / 一廠



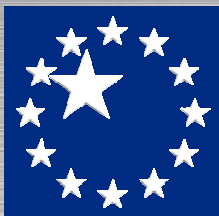

公司簡介 - 營業處所

中科園區 - 台灣精銳二廠



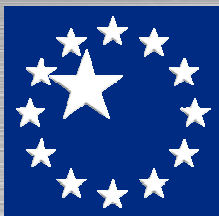

公司簡介 - 營業處所

中科后里園區 - 台灣精銳三廠



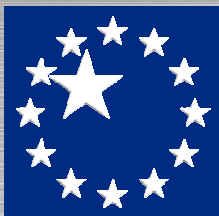

公司簡介 - 營業處所

台中七期 - 日月千禧酒店



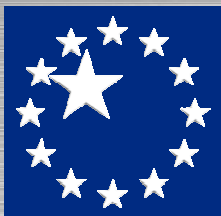

MILLENNIUM
VEE HOTEL
TAICHUNG
台中日月千禧酒店
You are the Centre of Our World



公司簡介 - 主要產品

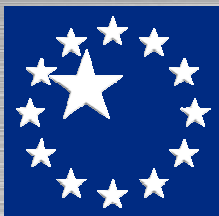



公司簡介 - 新品上市

MF-Seires



MD-Series

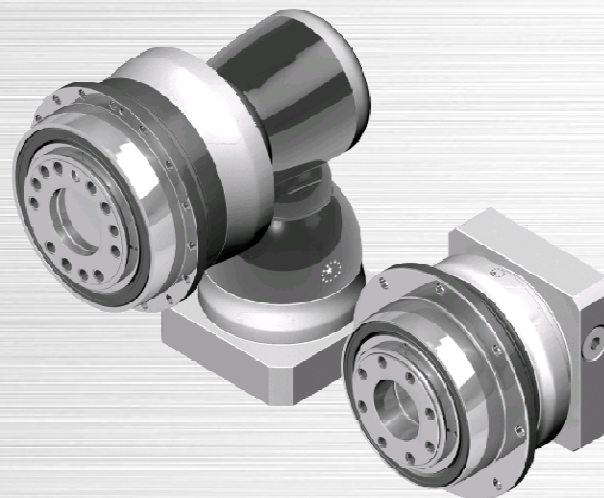

伺服用零背隙撓性聯軸器



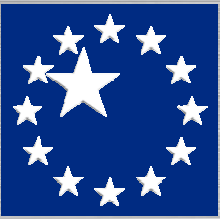

伺服用零背隙撓性聯軸器

Radial

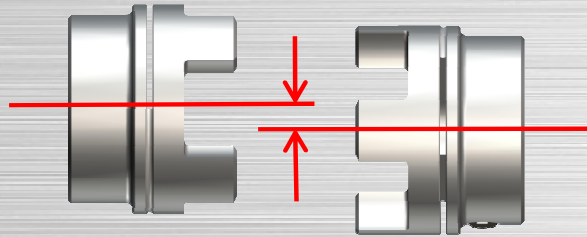

Axial

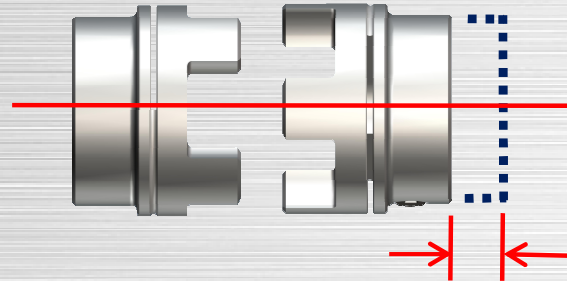

- To ensure the Precision Transmission and Positioning
- To reduce Assembly Difficulty
- To protect the Facility

Incline

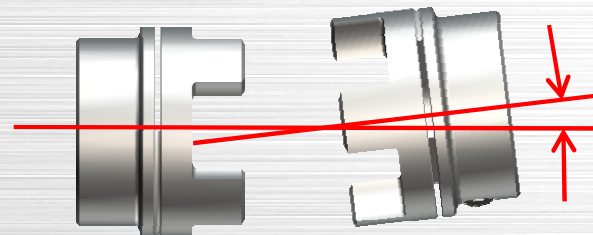

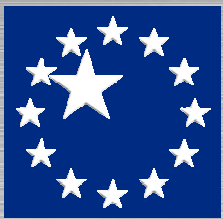

伺服用零背隙撓性聯軸器 應用

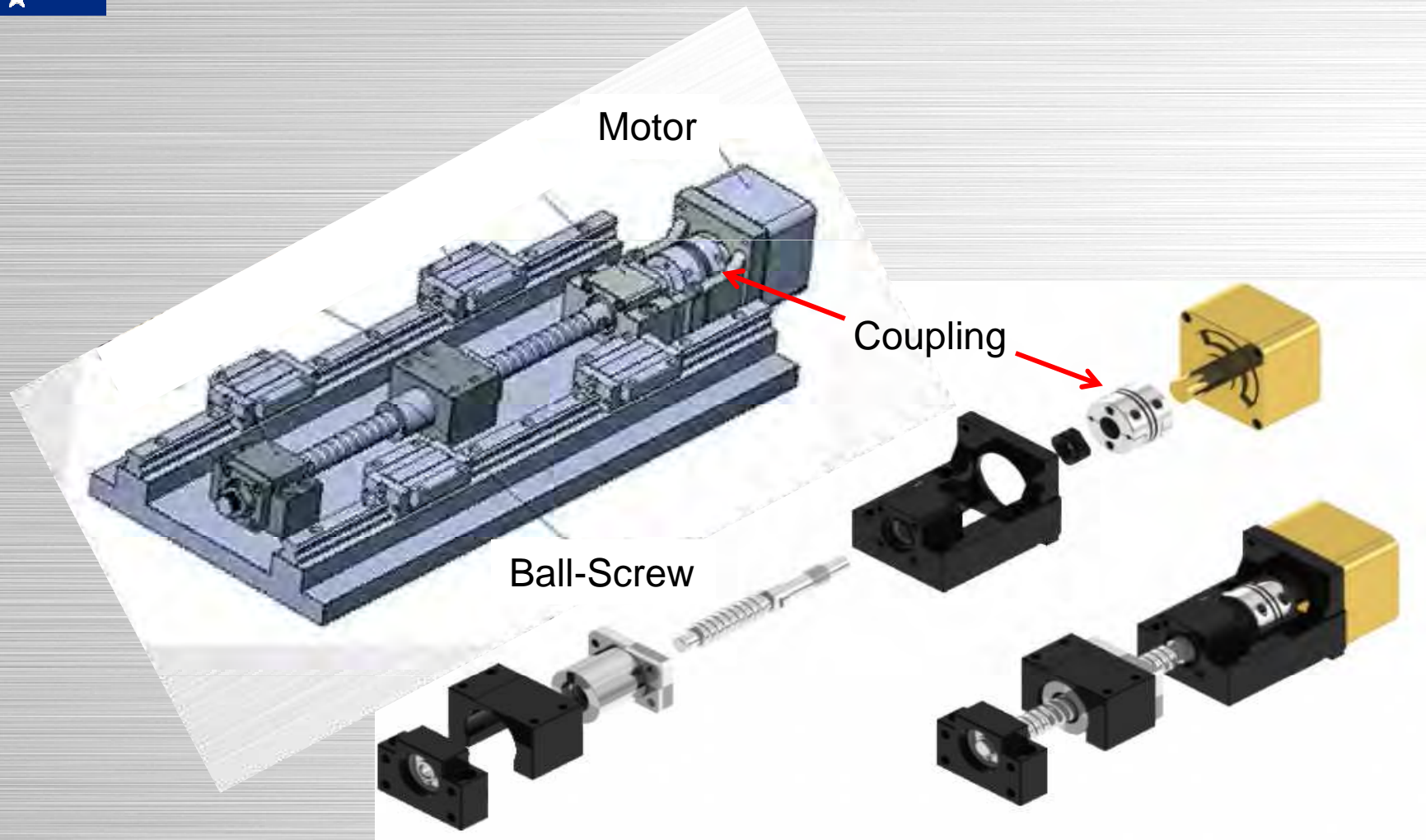



伺服用零背隙撓性聯軸器 應用



Spindle

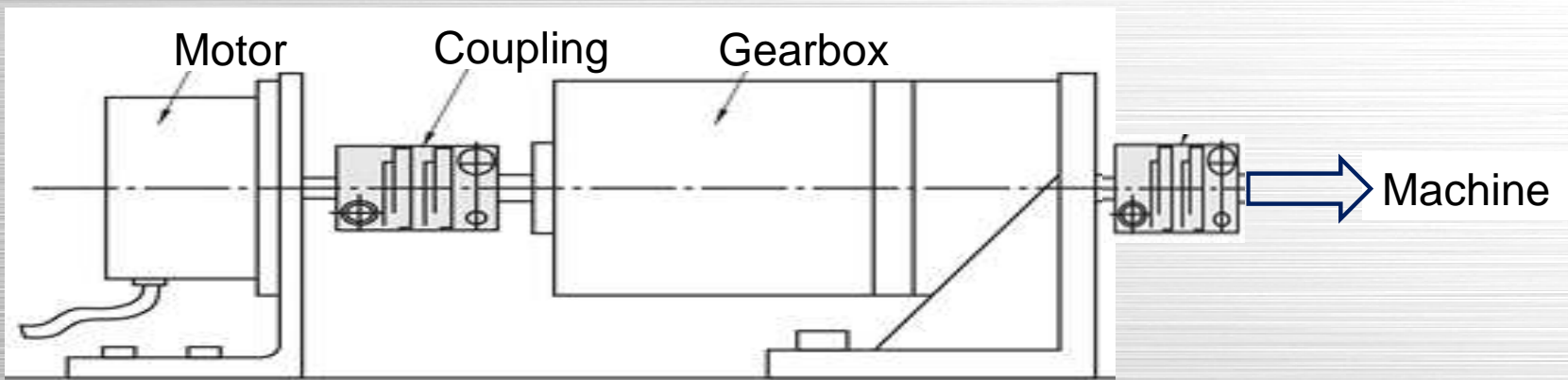
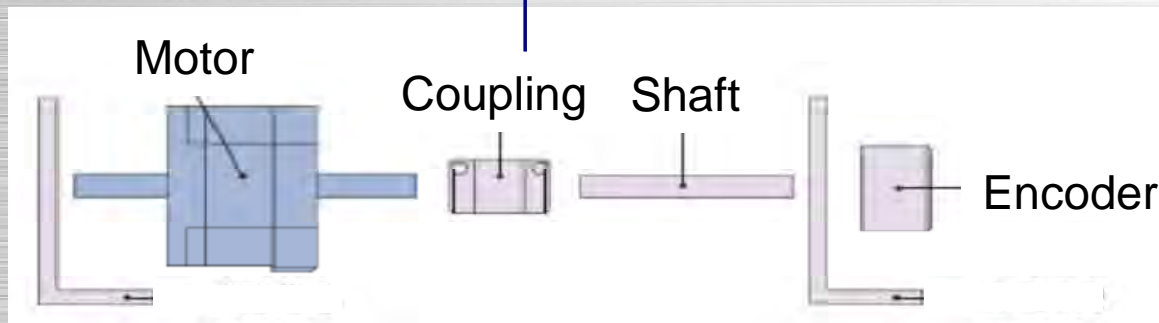

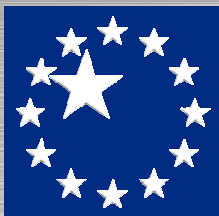

➤ 公司簡介

➤ **競爭利基**

➤ 營運實績

➤ 市場展望

➤ Q&A

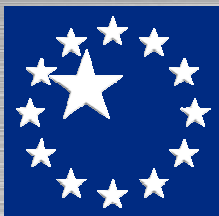

競爭利基－產業應用

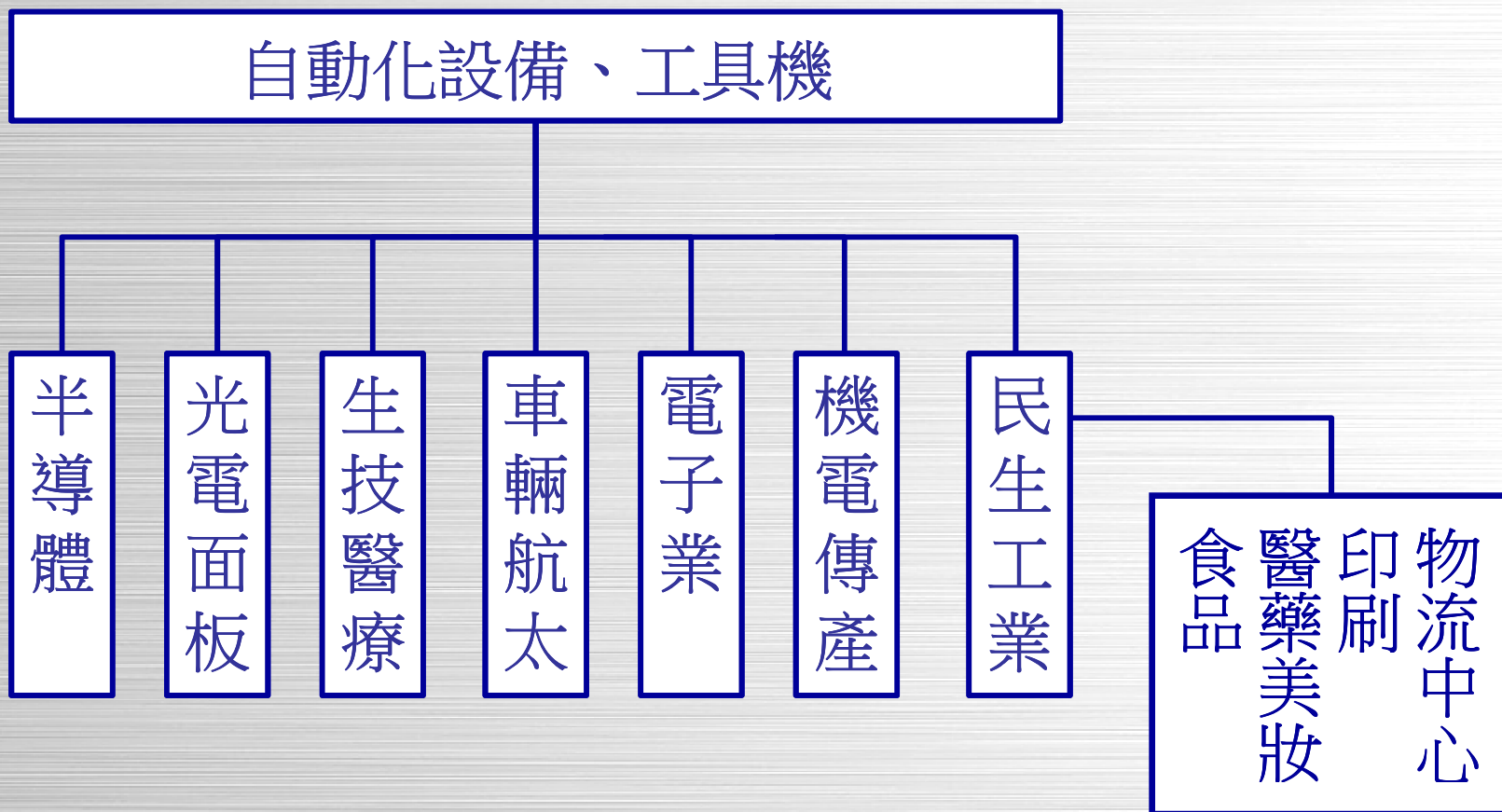

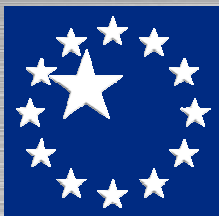

競爭利基－產業應用 (示意)



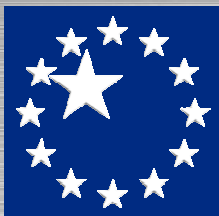

競爭利基 - 產業應用 (示意)



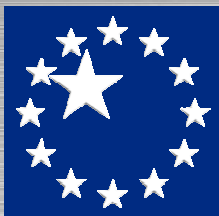

競爭利基－產業應用 (示意)

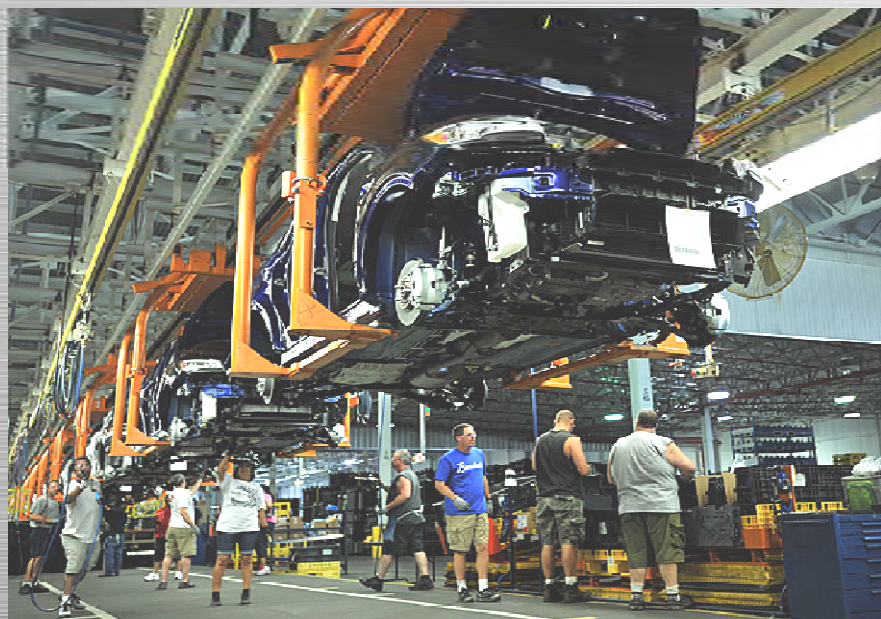

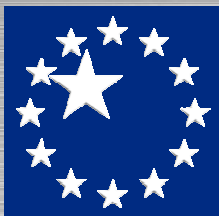

競爭利基－產業應用 (示意)



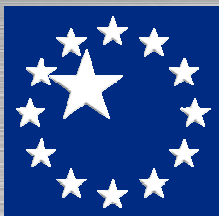

競爭利基－產業應用 (示意)



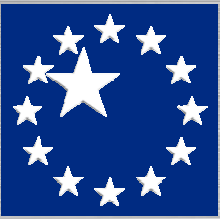

競爭利基－產業應用 (示意)



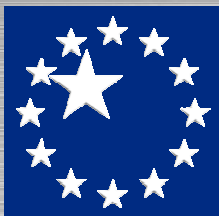

競爭利基 - 垂直整合

設計

品質管控 ++++
生產管控 ++++
成本管控 ++++
技術管控 ++++



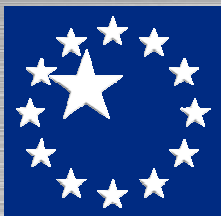

競爭利基 - 全球布局

37 APEX Exclusive Agents in 30 Countries !



Global Marketing !!



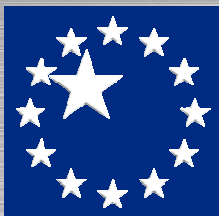

➤ 公司簡介

➤ 競爭利基

➤ **營運實績**

➤ 市場展望

➤ Q&A

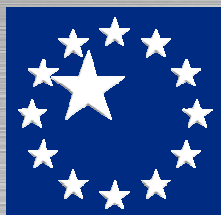

營運實績 – 產品營收比重

新台幣：千元

項目	2021年度		2022年度		2023年度	
	銷貨淨額	比例%	銷貨淨額	比例%	銷貨淨額	比例%
行星式減速機	2,558,584	77.74	2,690,447	78.44	1,961,424	72.99
客房及餐飲服務	345,235	10.49	435,168	12.69	521,882	19.42
其他	387,243	3.91	304,169	2.83	203,650	7.59
總計	3,291,062	100.00	3,429,784	100.00	2,686,956	100.00

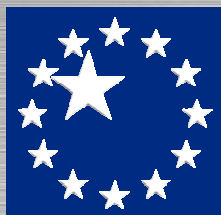

營運實績 – 銷售區域分布

新台幣：千元

項目	2021年度		2022年度		2023年度	
	銷貨淨額	比例	銷貨淨額	比例	銷貨淨額	比例
亞洲	1,944,509	66.57	1,877,654	63.30	1,223,207	57.37
美洲	369,075	12.64	467,647	15.77	405,223	19.00
歐洲	591,044	20.24	606,152	20.44	488,098	22.89
其他	16,257	0.56	14,601	0.49	15,718	0.74
總計	2,920,885	100.00	2,966,054	100.00	2,132,246	100.00

註：排除轉投資日月千禧酒店營業收入 / 日月千禧酒店2023年平均住房率 82%

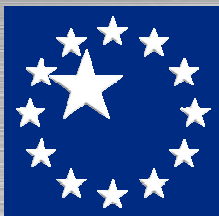

營運實績 – 毛利及獲利

新台幣：千元

項目	2021年度	2022年度	2023年度
營業收入	3,291,062	3,429,784	2,686,956
營業毛利	1,635,607	1,740,582	1,490,962
毛利率(%)	49.70	50.75	55.48

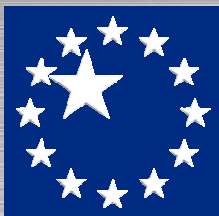

營運實績 – 毛利率分析

年度 個體	2021年度		2022年度		2023年度	
	毛利率	營收佔比	毛利率	營收佔比	毛利率	營收佔比
台灣精銳	49.2%	89.5	48.4%	87.3	51.1%	79.3%
日月千禧	59.3%	10.5	65.7%	12.7	72.6%	20.7%
合併	49.6%	100.0	50.7%	100.0	55.4%	100.0%

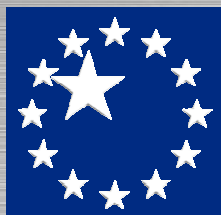

營運實績 – 毛利及獲利

新台幣：千元

項目	2021年度	2022年度	2023年度
營業收入	3,291,062	3,429,784	2,686,956
營業毛利	1,635,607	1,740,582	1,490,962
毛利率(%)	49.70	50.75	55.48
營業利益	1,091,623	1,154,187	905,765
稅前淨利	1,056,242	1,390,199	1,092,540
本期淨利	862,450	1,124,094	873,157
稅後EPS(元)	11.83	14.47	10.89

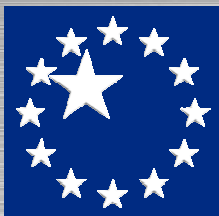

➤ 公司簡介

➤ 競爭利基

➤ 營運實績

➤ 市場展望

➤ Q&A

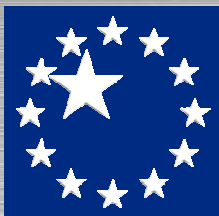

市場展望 — 自動化設備



資料來源: Precedence Research (2023)

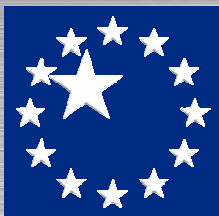

市場展望 — 工具機市場

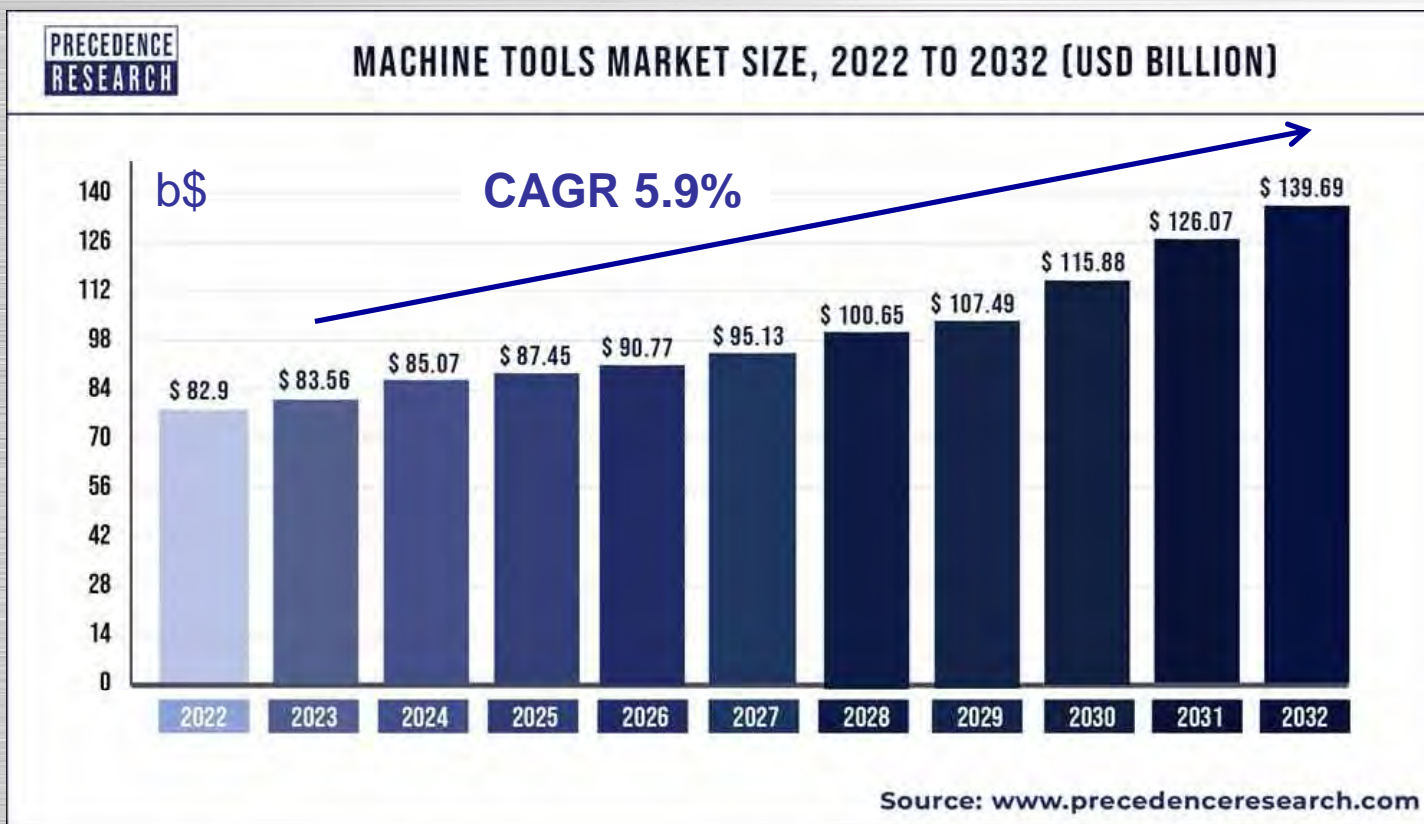

資料來源: Precedence Research (2023)

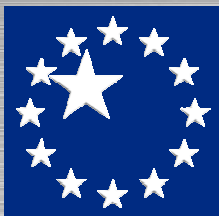

市場展望 — AI引領智慧製造

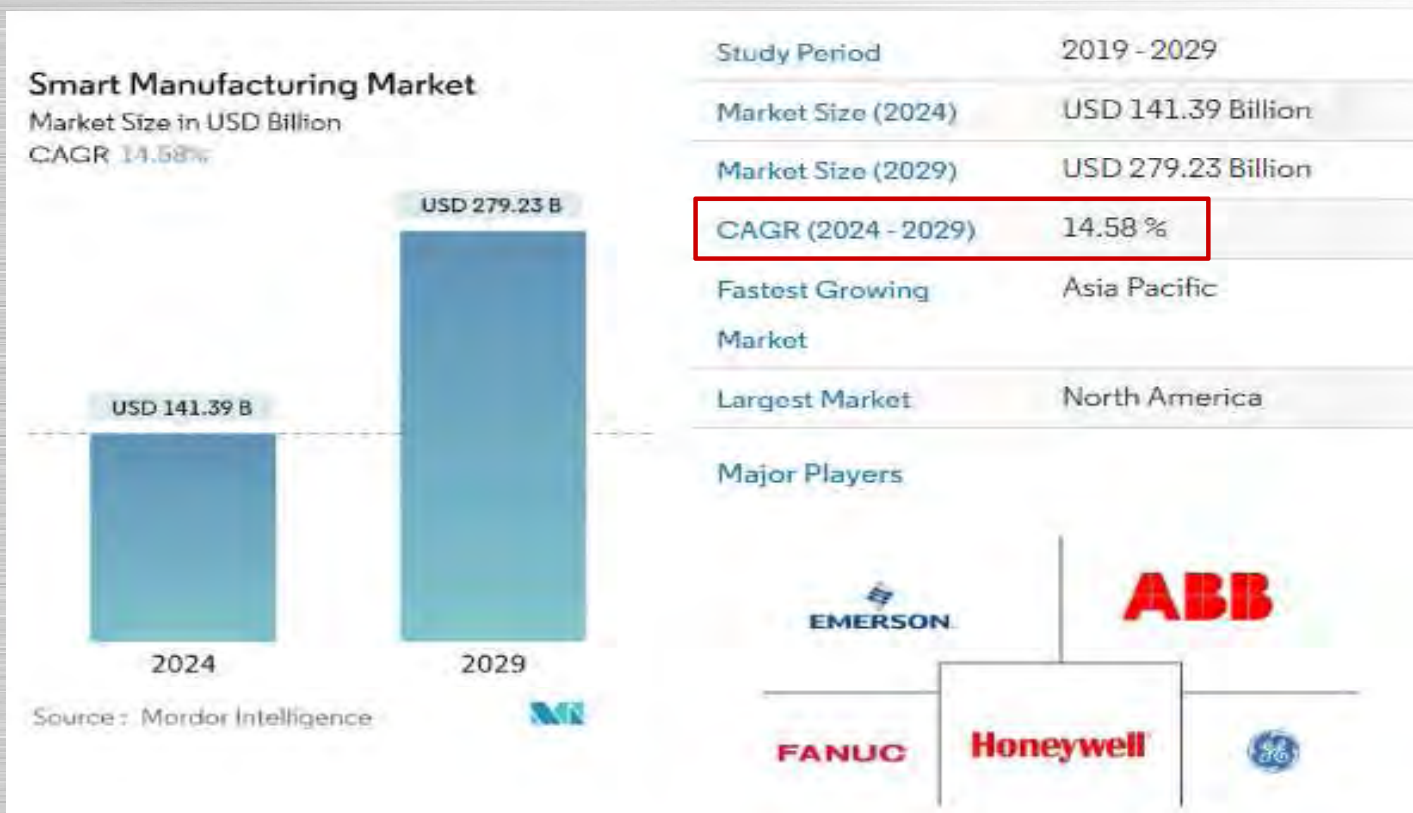

資料來源: Mordor Intelligence (2024)

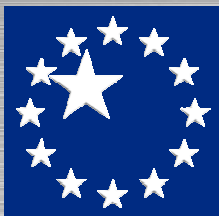

市場展望 — 倉儲自動化AMR

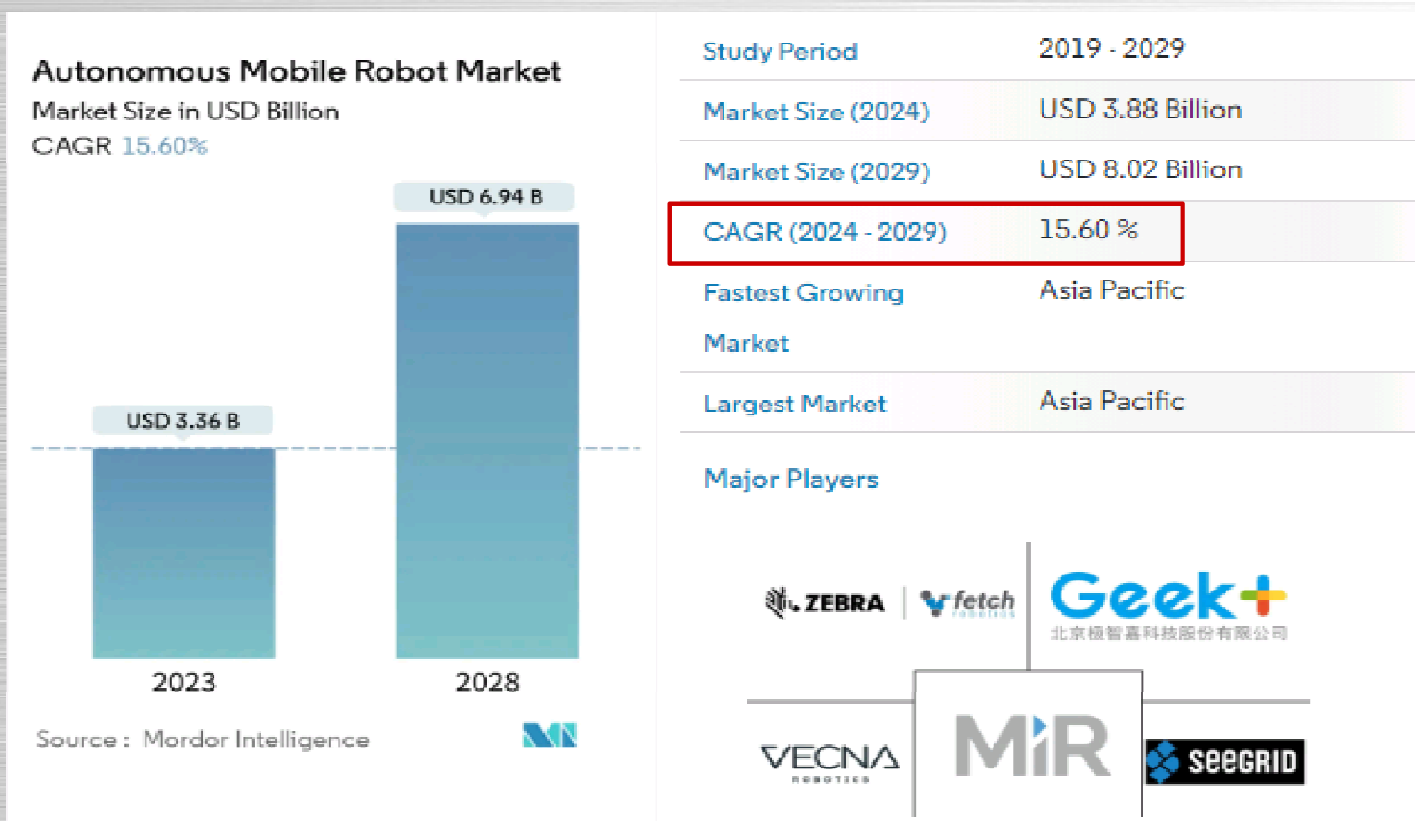

資料來源: Mordor Intelligence (2024)

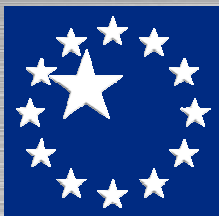

市場展望 — 倉儲自動化AGV



資料來源: Mordor Intelligence (2024)

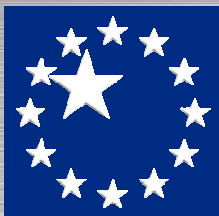

市場展望 — 生技精密器械

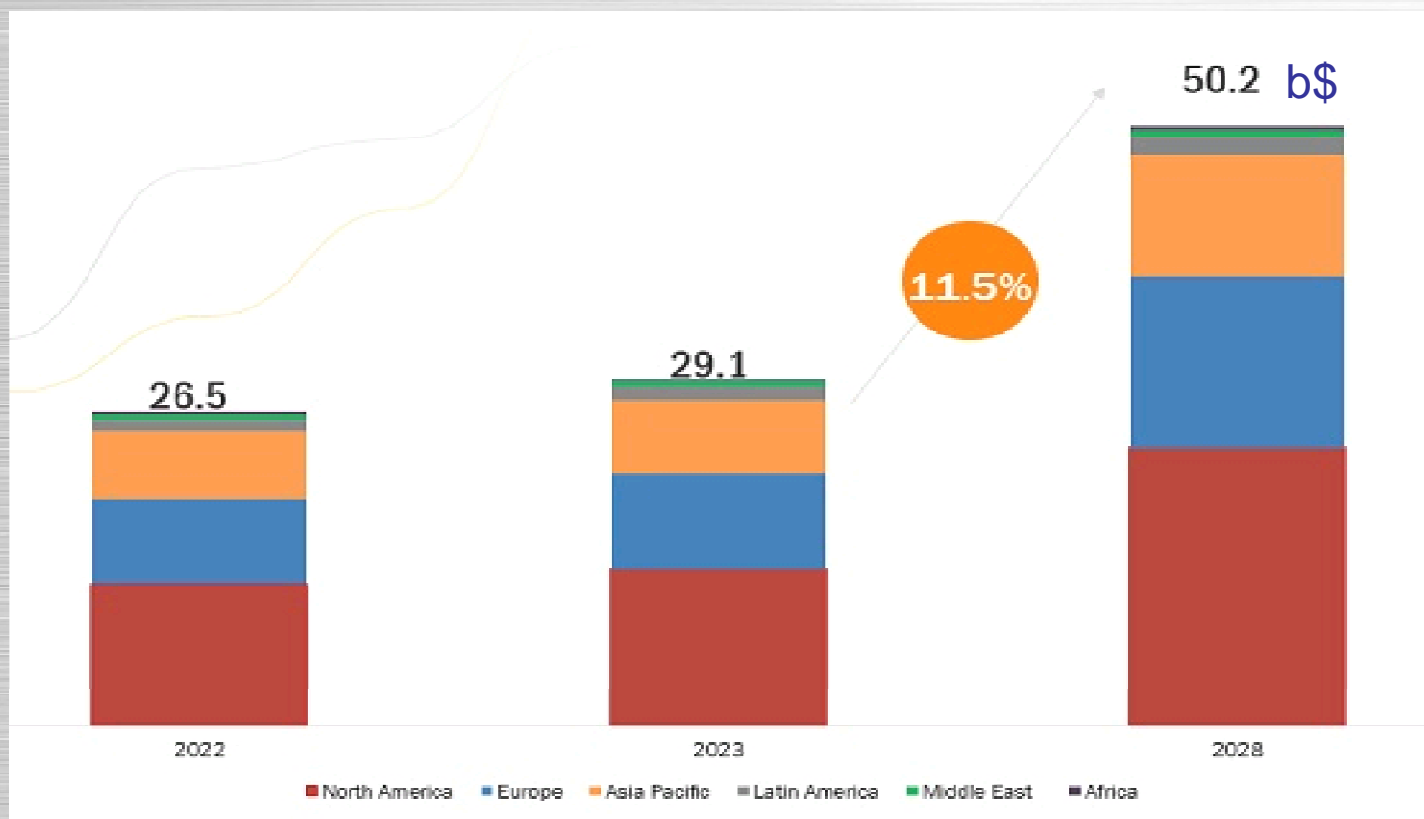

資料來源: Markets AND Markets (2023)

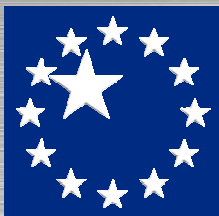

市場展望 — 伺服聯軸器應用產業

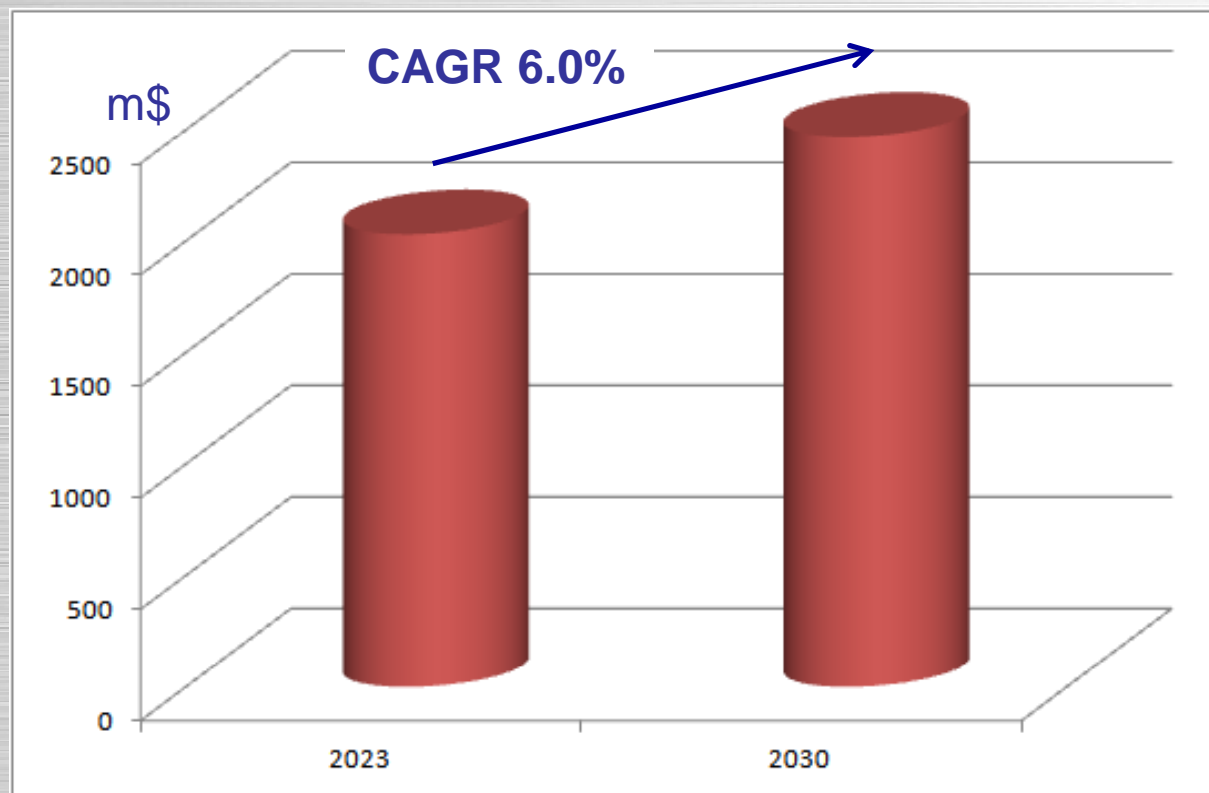

資料來源: Global Info Research (2023)

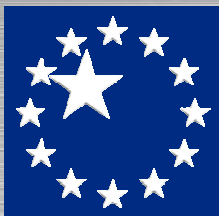

市場展望 — 來台旅客數

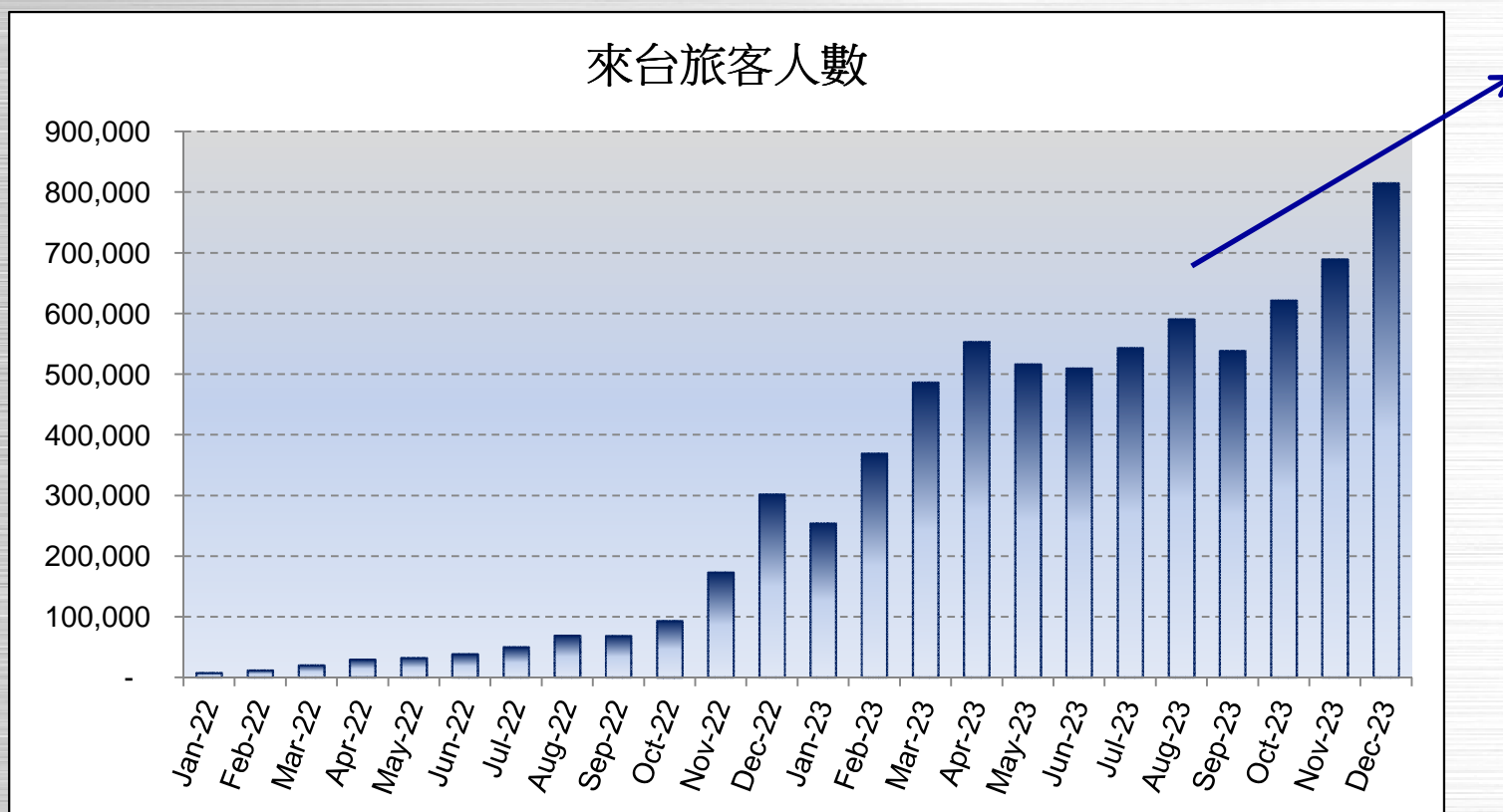

資料來源: 交通部觀光署 (2023/12)

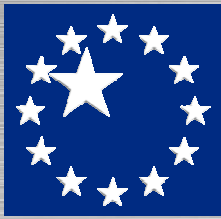

**Thank you
for your attention !**

Q & A

實體：發言條

線上：spokesman@apexdyna.com